



SPIRAL DOOR ALU









SPIRAL DOOR WITH ALUMINIUM
ROLLER SHUTTER PROFILES

**ITW**
INDUSTRIETORE

**TORMAFA**
Maschinenschutz- und Industrietore



ADVANTAGES AT A GLANCE

-  Opening speed up to 2.5 m/s
-  Door size up to 4,5 m x 4,5 m
-  Resistance to wind load up to class 4
-  Standard aluminium roller shutter profiles
-  Smooth running due to plastic spiral
-  RAL colour of your choice
-  Hinged guide rail
-  Non-contact protection through a light grid

SPECIAL FEATURES



EXTERIOR GATE FOR HIGH FREQUENCIES

Our high-speed spiral doors combine speed with high thermal insulation. The doors have been specially developed for outdoor areas with high frequency requirements. The high-speed spiral door opens significantly faster than a conventional sectional door and is therefore the ideal door system for frequent opening.

The sophisticated door leaf guide and the roll-up technology enable extremely fast opening and closing times. The door leaf is not wound onto a shaft but is held at a space-saving distance in a spiral. The door runs quietly and virtually wear-free thanks to the contactless movement into the spiral.

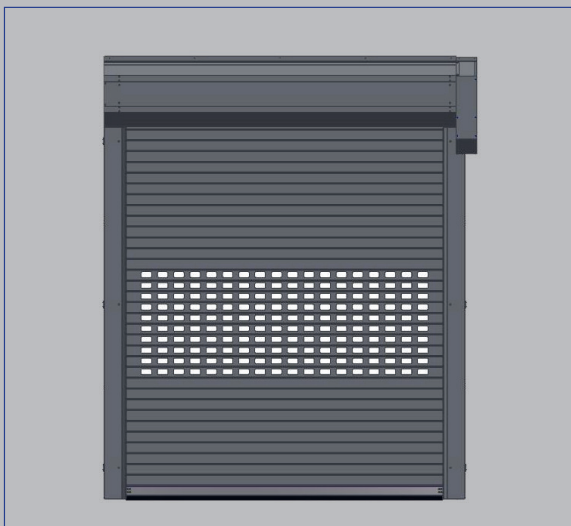
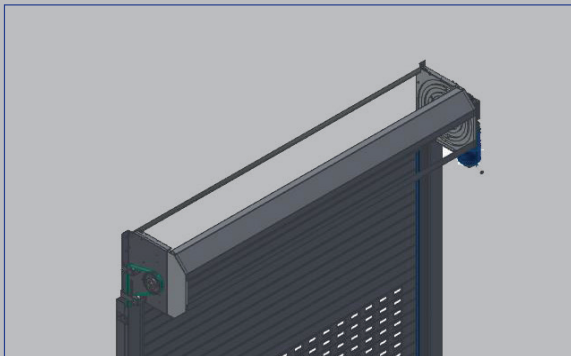

TECHNICAL DATA

- DR2100 microprocessor control unit with main switch and integrated frequency inverter
- Lintel heights:
 - up to clear height 2500 mm - 650 mm Fitting
 - up to clear height 3500 mm - 800 mm Fitting
 - up to clear height 4500 mm - 900 mm Fitting
- Standard aluminium roller shutter profiles, RAL paint finish possible
- Smooth opening into a stable and wear-free plastic spiral thanks to non-contact roll-up technology
- Smooth and durable operation thanks to toothed belt transmission
- Sealed tracks on both sides

SAFETY

- Access protection by means of all-round cladding
- Passage monitoring by means of light grid
- Emergency opening by reel chain
- Signal lights and traffic light control (optional)

OUR FURTHER PRODUCT RANGE

SPIRAL DOOR ALU (D) | 18.03.2024 | TECHNICAL CHANGES RESERVED



SPIRAL DOORS



FOLDING DOORS



HORIZONTAL HIGH-SPEED DOORS



VERTIKAL HIGH-SPEED DOORS



SWING DOORS



STRIP CURTAINS



MACHINE PROTECTION DOORS



SECTIONAL DOORS



STEEL / ALUMINIUM ROLLER DOORS

SCOPE OF APPLICATION



INDUSTRY



TRANSPORT



LOGISTICS



AUTOMOTIVE



M. PROTECTIONS



CLEAN ROOM



SUPERMARKET



FOOD



COOLING AREA



ATEX

ITW Industrietore GmbH
Adolf-Kolping-Straße 14
73072 Donzdorf
Germany

Tel. +49 7162 9129-60
Fax +49 7162 9129-64
info@itw-torsysteme.de
www.itw-torsysteme.de

ITW
INDUSTRIETORE